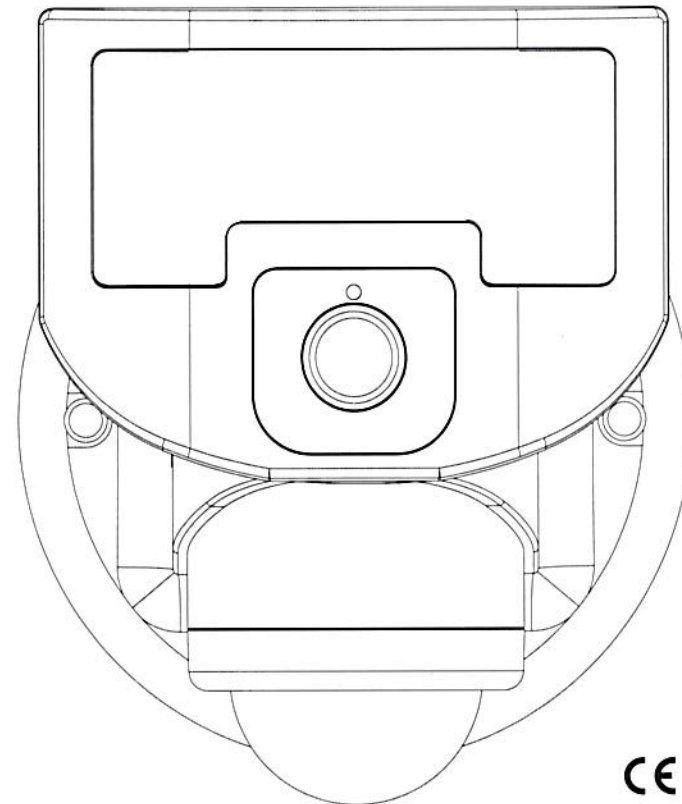

USE AND CARE GUIDE**MOTORIZED MOTION TRACKING SECURITY LIGHT**

Protect yourself. Please read these instructions carefully prior to installation and retain them for future reference. Failure to follow any of these instructions could void product warranties.

For questions regarding this product or warranty, please contact Customer Service at :
Email : tech@nightwatcherproled.com

IMPORTANT SAFETY INSTRUCTIONS

- To reduce the risk of death, personal injury or property damage from fire, electric shock, falling parts, cuts/abrasions and other hazards read all warnings and instructions included with and on the fixture box and all fixture labels.
- Before installing, servicing or performing routine maintenance upon this equipment, follow these general precautions.
- For Commercial Installation: Service and maintenance of this fixture should be performed by a qualified licensed electrician.
- For Residential Installation: If you are unsure about the installation or maintenance of this fixture, consult a qualified, licensed electrician.

Do not mount the unit against flammable surfaces.

The motion detector will not operate correctly if it is installed:

- Near the outlet of a central heating boiler
- Near an air conditioning unit
- Pointing directly at moving vehicles
- Within sight of reflection from moving water
- Where other lamps could shine on the sensor
- Fixtures can NOT be used with a dimmer switch, motion or occupancy sensor and other electronic switching devices unless otherwise designated. LED fixtures must be powered directly off a switch circuit.
- Do not install more than one motion sensor light on one wall switch.
- This fixture should not be used in areas with limited ventilation or high ambient temperatures.
- This fixture is intended to be connected to a properly installed and grounded.
- These instructions do not claim to cover all details or variations in equipment or provide every possible contingency to meet in connection with the installation, operation or maintenance. Should further information be needed, you may contact Customer Service at :

⚠ WARNING: RISK OF ELECTRICAL SHOCK

- Turn off electrical power at fuse or circuit breaker box before wiring the NW 950 fixture to the power supply.
- Verify that the supply voltage is correct. Connect fixture to a power source. (AC 100-240V 50/60Hz)
- Make sure all electrical and grounded connections are in accordance with the National Electrical Code and any applicable local code requirements.
- All wiring connections should be capped with UL /CE listed connectors.

⚠ CAUTION: RISK OF PRODUCT DAMAGE

- Do not mount or support these fixtures in a manner that can cut the outer jacket or damage wire insulation.
- Avoid covering LED fixtures with insulation, foam, or other material that will prevent convection or conduction cooling.
- Never connect an LED product directly to dimmer packs, occupancy sensors, timing devices or other related control device, unless individual product specifications deem otherwise.
- Unless individual product deems otherwise: do not exceed fixtures maximum ambient temperatures.
- LED products are Polarity Sensitive. Ensure proper polarity before installation.
- Electrostatic Discharge (ESD) can cause damage to LED fixtures. Personal grounding equipment must be worn during all installation or servicing of the unit.
- Do not touch the individual electronic components, it may cause ESD, shorten lamp life or alter performance.

⚠ CAUTION: RISK OF INJURY

- Wear gloves and safety glasses at all times when removing fixture from carton, installing, servicing or performing maintenance.
- Avoid direct eye exposure to the light source while it is on. Led lamps are extremely bright. Under no circumstances should you stare into the Led light beam, this may cause irreparable damage to the eyes.
- Account for small parts and destroy packaging materials, as these may be hazardous to children

⚠ WARNING: RISK OF BURN

- Allow fixture to cool before handling. Do not touch enclosure of light source.
- Do not exceed the maximum wattage marked on the label.
- Keep combustible and other materials that can burn away from the luminaries, fixture and lamp/lens.

PRE- INSTALLATION

Before assembling the product, make sure all parts are present. Compare parts with package contents list and hardware contents. If any part is missing or damaged, do not attempt to assemble the product.

Estimated assembly time: 30 minutes.

Note: The NW950 should be installed by a person with experience in household wiring or by a qualified electrician.

The electrical system and the method of connecting this fixture must be in accordance with the National Electrical or local building regulations.

Install the fixture on a height between 6.6ft (2m) - 10ft (3m) above ground

Recommended installation height for optimum coverage

- Install the motion sensor 6.6 ft / 2 meters - 10 ft / 3 meters above the ground. Motion sensors are less sensitive when installed below 6.6 ft / 2 meter or above 10 ft / 3 meter.
 - The NW950 features 3 fixed independent motion sensor zones. Each sensor zone is 70° degrees and the total sensor coverage area is 210° degrees
- The detection distance per zone is 39.37ft/12meters plus

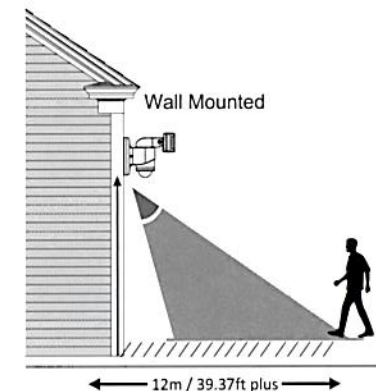

Note: Outdoor ambient temperatures could effect the infrared emissions to the fixture sensors and the detection distances. The heat signature of a person or object during spells of higher ambient temperatures could decrease the detection distances slightly and during cold temperatures the detection distance could increase

MOUNTING LOCATIONS

- Determine the mounting location – a solid is preferable.
- When selecting your installation area its import to be aware of possible factors that could cause false triggering ; such as direct sunlight, window glare or refection, air condition units, swimming pool water reflection, direct street lighting or large vegetation in the installation area.
- Although the NW950 is weatherproof (IP65) to prolong it's lifespan it is sensible to install the unit in an area that is not directly exposed to extreme weather conditions.

1700 lumens per LED Light beam angle = Tridirectional

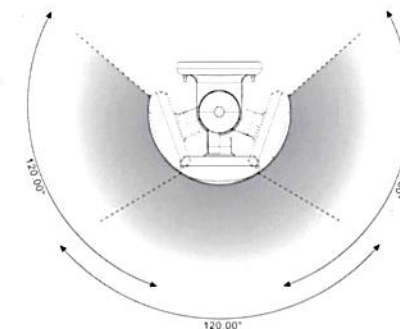

PRE-INSTALLATION (CONTINUED)

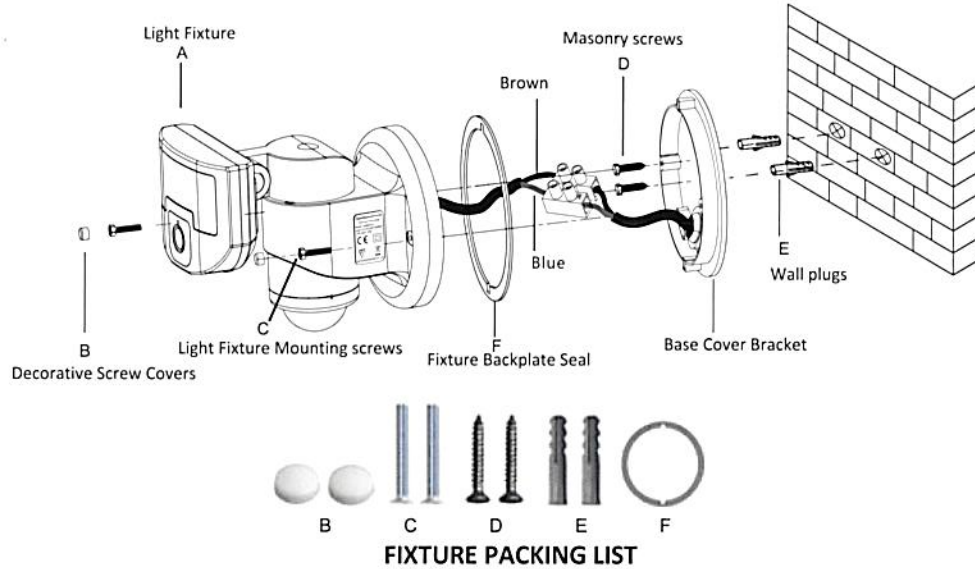

FIXTURE PACKING LIST

Part	Description	Quantity
A	NW950	1
B	Decorative Screw Covers	2
C	Light Fixture Mounting screws	2
D	Mounting screws	2
E	Wall plugs	2
F	Fixture Backplate Seal	1
G	8gb memory card included and inserted into the fixture card slot	1

Mounting Hardware included. Silicone Sealant is required (but not provided).

Tools Required for Installation (Not included):

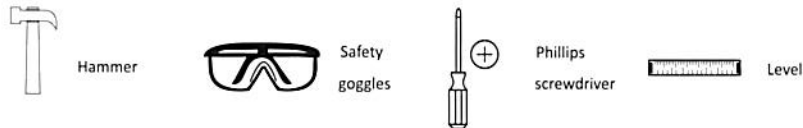

LIGHT HEAD ADJUSTMENT

Adjust the light head with camera for the desired light beam angle with a manual tilt option of 30 degrees

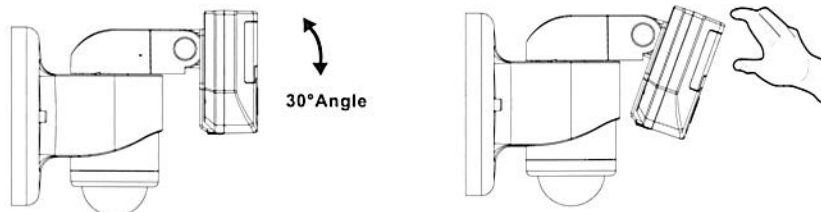

INSTALLATION STEPS

Step 1. Installing the Light Fixture

Loosen the NW950 mounting screws to remove the base cover bracket and seal. Feed the wall power cable through the back base cover bracket and through the Fixture Backplate Seal (C) before securely fixing the wall plate and connecting the wires to the terminal block.

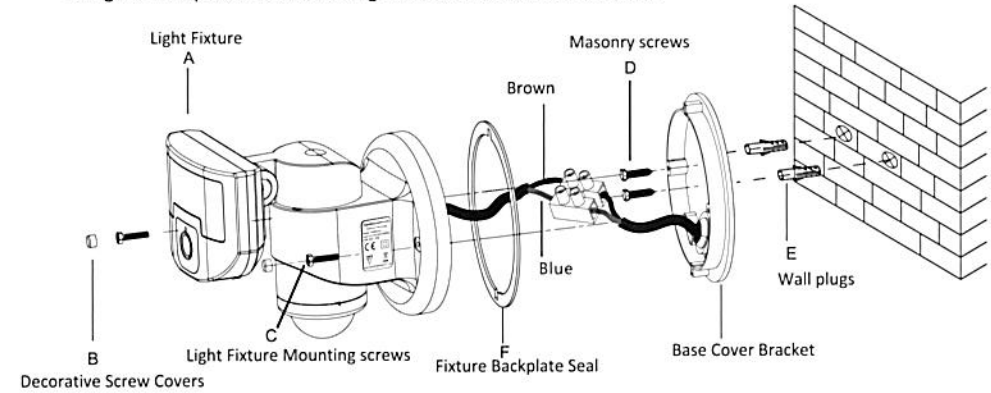

WARNING:

Risk of an electric shock. Disconnect power at fuse or circuit breaker before installing or servicing the Light Fixture.

Step 2. Connect the NW950 cables to the terminal block

Note: Make sure the polarity is correct and do not power more than one NW950 on a single switch.

- Connect the Brown wire (live wire) from the AC power cord to the single Brown wire coming from the light fixture on the terminal block. Brown to Brown (L)
- Connect the Blue wire from the AC power cord to the single Blue wire coming from the light fixture on the terminal block. Blue to Blue (N)

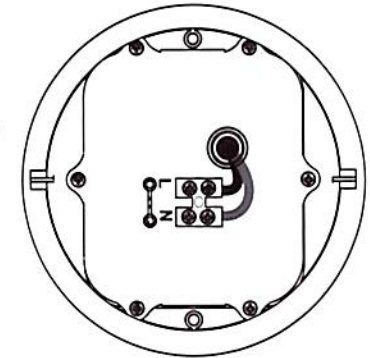

Step 3. On completion of the wiring connections,

Ensure the fixture is properly mounted on the wall by using the masonry screws and the wall plugs.

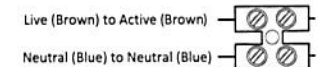

Ensure the seal between the base cover bracket and the NW950 is properly seated and apply a sealant between the base cover bracket and the wall to guard against any water entry.

Align the light fixture with the base cover bracket and secure it with two Light fixture Mounting screws (C). Thereafter cover the screw heads with the Decorative Screw Covers (B)

INSTALLATION(CONTINUED) CONNECTING THE NW 950 TO THE WI-FI NETWORK

The NightWatcher has a built-in Wi-Fi module which can be connected to the local Wi-Fi network, enabling the broadcast of live video and message alerts to a dedicated app, running on an iOS or Android smartphone. The performance of the NightWatcher is dependent on the quality of the Wi-Fi signal and - we therefore recommend the following prior to installation;

- Ensure the NightWatcher is installed within close range of the Wi-Fi router.
- Stand at your preferred installation location and test the strength of the Wi-Fi signal using a smartphone.
- Avoid thick exterior walls as these can limit the range of the Wi-Fi signal.
- If the Wi-Fi signal is not strong enough, consider the following options;
 - If possible, relocate the router closer to the NightWatcher
 - Install a Wi-Fi Range Extender closer to the NightWatcher

Installation Summary

The installation process involves the following steps;

1. After installation, power-up and switch the power on to the fixture.
2. Scan the QR code appropriate to your phone to download the free "Tuya Smart" App to an iOS or Android device.
 - Tuya Smart(with Tuya logo):[QR code for downloading](#)



3. The NightWatcher unique ID is permanently connected to the Wi-Fi.
4. Once the NightWatcher is successfully connected, an acceptance sound will be heard when connected.

NB: If the connection is not successful, you can reset the NightWatcher;

- Open the SD card cover and push the reset button in for 3 seconds an sound will indicate the reset has been successful and then repeat the Wi-Fi pairing process below.

CONNECTING THE NW 950 TO YOUR PHONE OR TABLET

Firstly ensure your phone or tablet is connected to the Wi-Fi network you intend to use for the NightWatcher

1. Open the Tuya Smart App and follow the steps on your smartphone

2. First time in, select "Sign Up" and Register to obtain a verification code to create your unique account

Note: Should you already use the APP on your phone then select Log in

3. Input your verification code and Set your password, then select "Done".

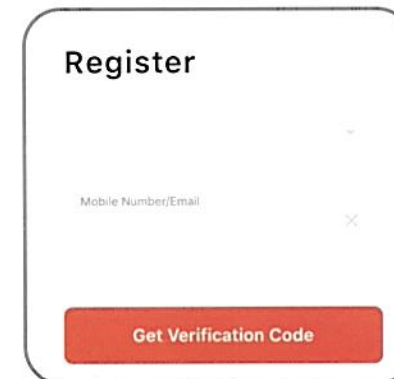
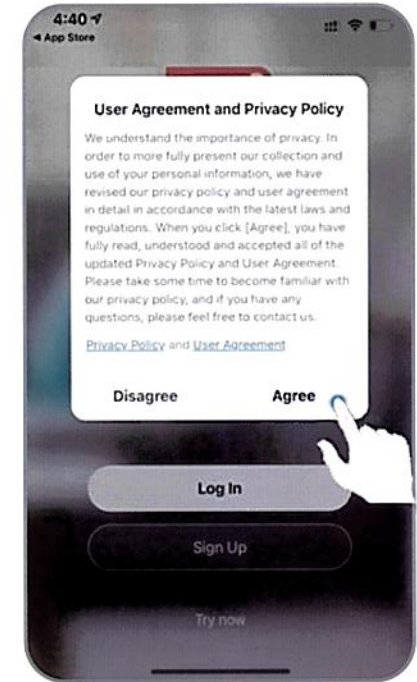
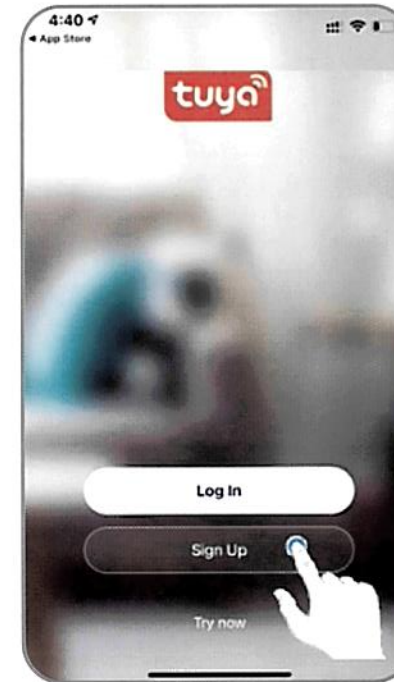

APP INSTALLATION CONTINUE

4. Add and connect your NW 950 to the Wi-Fi network following these easy 5 screenshots steps below:

- 1) Click on Add Device explained here below(only to add to existing devices click top right )
- 2) Click on Security & Video Surveillance
- 3) Click on Smart Camera(Wi - Fi)

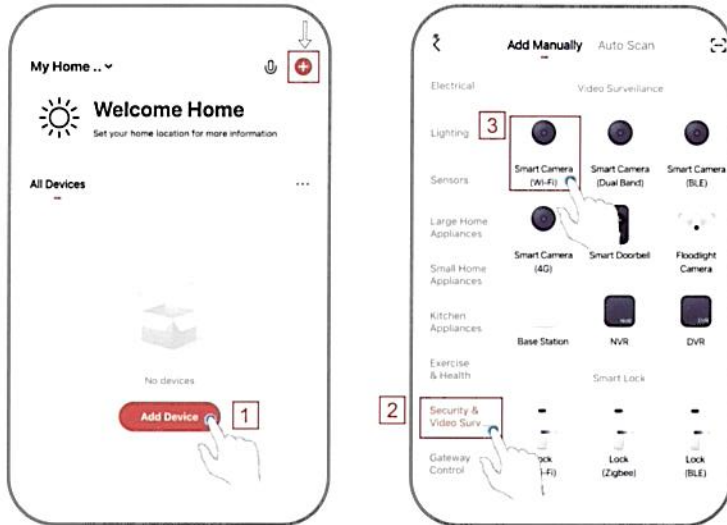

4) After step 3 click next by following the APP screenshot guideline here below

5) Ensure to select 2.4 GHz and enter your Wi-Fi details and password and click next

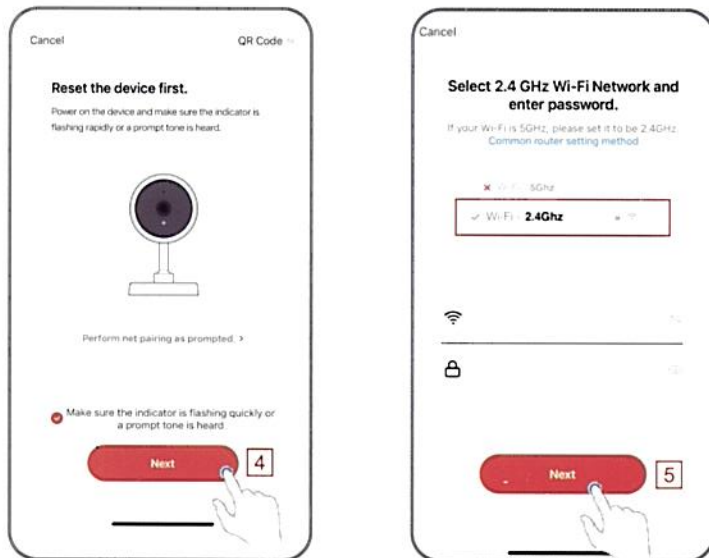

PAIR AND CONNECT THE NW 950 FIXTURE TO YOUR ROUTER AND NETWORK

5. There will be 2 (two) consecutive electronic beep sounds as indication that you can pair and connect the NightWatcher to your router and network - Your phone will generate a QR code which is pointed at the NightWatcher camera lens at a distance between 15 to 20cm apart to connect to the Wi-Fi network. On acceptance you will hear 1 electronic beep as indication the process was successful then press "I heard a prompt" explained on the screenshot here below.



Point the QR code displayed on your phone at the NW 950 camera (Approx. 15- 20cm distance)
Once the NightWatcher is successfully connected, an acceptance sound will be heard when connected

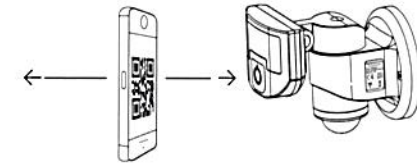

NB: If the connection or pairing process is not successful, you can reset the NightWatcher by following the below 2 options :

Option 1 . To delete the NightWatcher camera fixture from the App screen , and then to repeat the Wi-Fi pairing process explained below on the screenshots with 3 easy steps .

1. Click on menu bar
2. Click on Device Management
3. Drag the camera fixture to Remove Device

Option 2 . To push the "Rotation Off" icon on the App screen for the LED head with the camera to be static in the center position of the fixture and then to open the SD memory card cover that is located at the bottom of the LED lamp head and push the reset button in for 3 seconds . A notification sound will indicate the reset has been successful, and then repeat the Wi-Fi pairing process below.

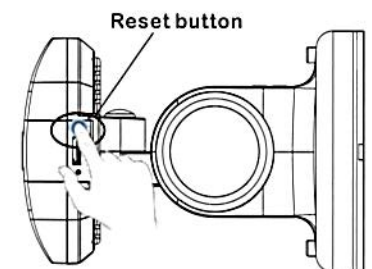
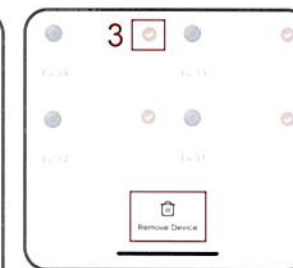
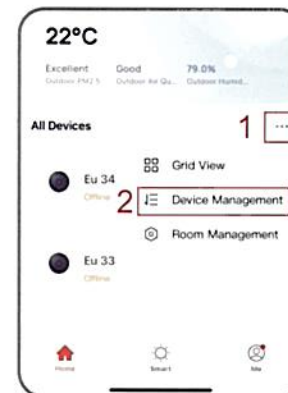

PAIR AND CONNECT THE NW 950 FIXTURE TO YOUR ROUTER AND NETWORK

6. When the NW 950 fixture is successfully connected to the Wi-Fi network, the camera images from the installed NW 950 fixture can be viewed.

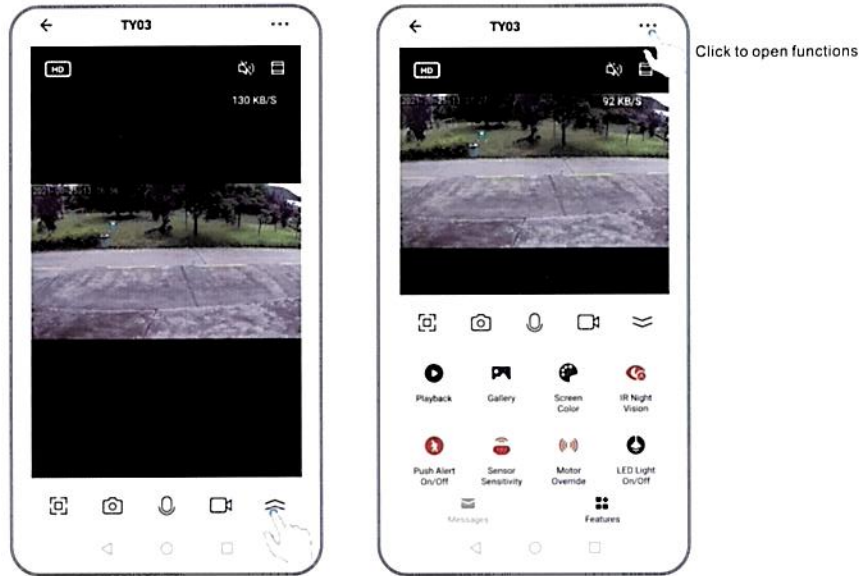

Click to open functions

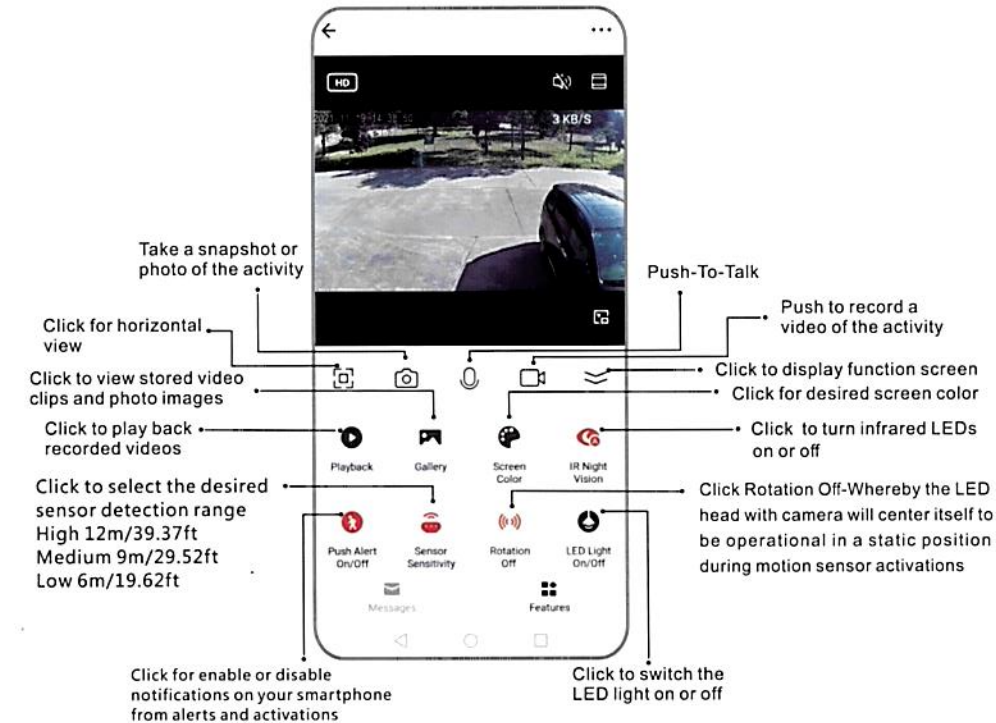

THE NW 950 CAMERA MEMORY CARD STORAGE FEATURE

There is a 32gb memory card included and inserted into the NightWatcher. The NightWatcher memory card loading options for onboard storage is from 8GB until 128GB.

When the memory card reaches its maximum capacity, the newest video overwrites the oldest video ensuring that your device will continuously record.

Note : Should you choose to change the memory card with a bigger memory capacity card for onboard storage, follow the steps here below before inserting a new memory card into the NightWatcher:

1. Step 1. Push the "Rotation Off" function on the APP that will allow the LED head to rotate to the center of the fixture and remain in a static position without moving when inserting the memory card.
2. Step 2. Open the SD card silicone flap located at the bottom of the LED head and insert the Micro-SD card with the text facing up, then close and secure the SD card flap.

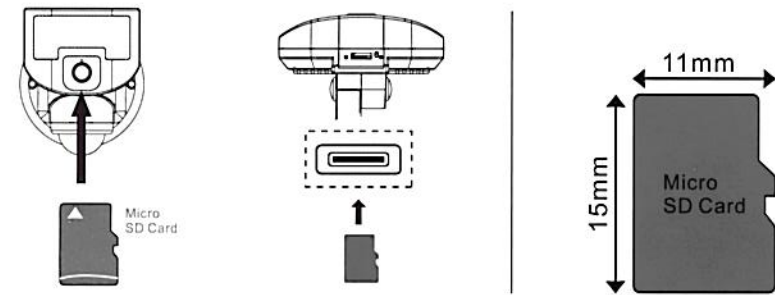

After you inserted the micro memory card into the NightWatcher follow the APP steps with screenshots here below

- 1) Step 1 Press the multi-function bottom "... " on right top corner.
- 2) Step 2 Click on storage settings (can only see the storage column when SD card has been inserted correctly)
- 3) Step 3 Click on format when the micro memory card will be used for the first time
- 4) Step 4 Select and choose non-stop recording or event recording.



For using Amazon Echo or Google Home click on "Me" shown here below on the App screenshots with options .

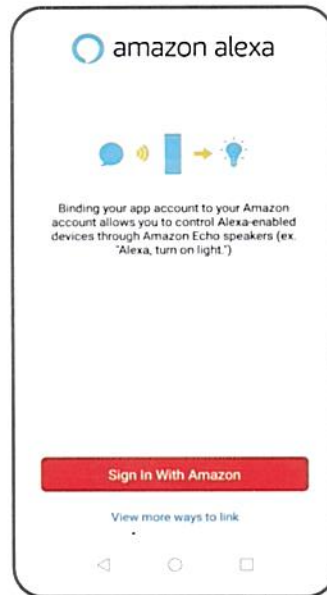
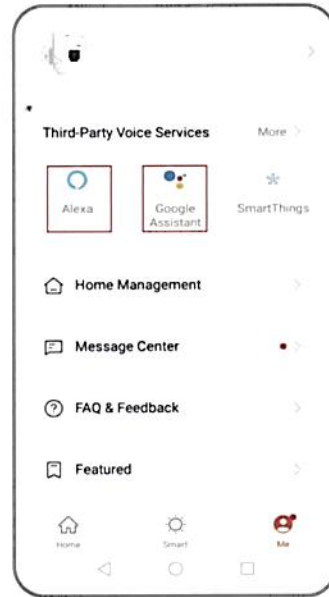
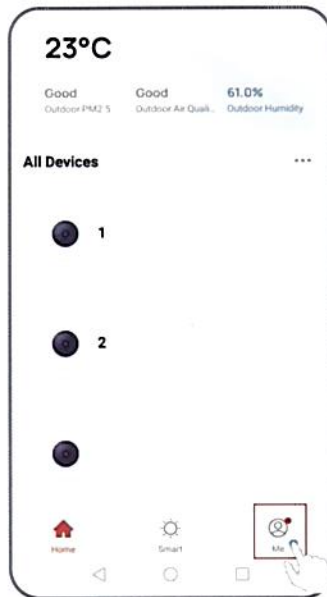

App functions Summary

1. App Control Sensitivity Adjustment: 12 m/39.37ft High,9 m / 29.52ft Medium,6 m /19.68ft Low
2. App Control IR's infrared illumination to enhance camera images
3. 2 way audio communication and record video to on-board SD card
4. App Control switching LED light on or off
5. App Control to receiver motions sensor activations from notifications or alerts on your smartphone
6. App Control to select the motor override function

SPECIFICATIONS

1. Detection Method: Passive Infrared Sensor (PIR).
PIR measures infrared light radiating from a person or object in its field of view .
2. Sensor Range: up to 39.37ft/12meters across a horizontal detection zone of 210° degrees
3. Input Voltage : 100 – 240V 50/60Hz
4. Lumens : 1700
5. Weatherproof rating – IP65
6. Lux : Built-in PhotoCell - Fixture auto active from dusk to dawn

CARE AND CLEANING

To prolong the original appearance of the fixture regularly clean the NightWatcher and camera lens with a soft damp cloth. Do not use paints, solvents, or other chemicals on this light fixture. They could cause a premature deterioration of the outer body of the fixture and will not be covered by the warranty.

Important - Do not spray the NW 950 directly with a hose or power washer.

FREQUENTLY ASKED QUESTIONS

How far can I have my NW 950 from my router?

This distance will vary depending on your house, Wi-Fi signal reach and router. We, therefore, recommend testing the Wi-Fi connection strength to get an optimal signal in the installation area before installing the 95 fixture. If the signal is poor, you can resolve this by relocating your NightWatcher , upgrading your broadband and/or router, or using a WIFI signal booster.

I am unable to connect my NightWatcherto my Wi-Fi system.

Please make sure the Wi-Fi signal strength in the location where the camera is installed is good (check with your phone).

Should I use 2.4GHz or 5GHz Wi-Fi?

The NightWatcher is only capable of connecting to the 2.4GHz Wi-Fi frequency.

How many users can be connected to a NightWatcher at once?

There is no specific limit, however we recommend no more than 4 connections at once; the available bandwidth strength of the internet connection that the NightWatcher is using may limit multiple connections at the same time.

Basic steps should it happen you lose connectivity between the NightWatcher and the router

1. Reset your router by switching it off and back on to establish a fresh connection
2. Reset the unit - explained on page 8 of the manual

General information

Each house or business building /premises has different structural layouts and uses different routers and all these factors have to be taken in account during the planning stage when installing and set-up the NightWatcher fixture to ensure enough interaction signal strength to the dedicated internal router .

1. Make sure the mobile device you are using is connected to the same Wi-Fi router the NightWatcher is connected to and also try your 4G network.
2. Make sure your wireless network is available in the area you are going to install the NightWatcher Depending on the layout of your house, and the position of your Wi-Fi router, you may also run into connectivity issues if the Wi-Fi signal strength is weak due to brick walls or excessive amounts of steel in the construction.

If the signal strength of your Wi-Fi router is weak, there are several ways to improve transmission for example by just changing your router or NightWatcher to receive an optimum or better signal.

Testing your bandwidth:

1. Run a speed test on your mobile phone connected to your network to see how much bandwidth your Internet connection has available.
2. Temporarily disconnect other devices in your home from the Internet, one at a time. You can do this by switching off Wi-Fi, unplugging ethernet cables, or by turning the devices off. Be sure to also disconnect any unattended devices that might be streaming music, downloading updates, or running a torrent program.
3. After disconnecting one of your devices, run a secondary speed test to see if your Internet connection now has more bandwidth available.

You may have to be more conscious of "bandwidth traffic " on your network: „such as HD movie downloading or streaming, music streaming, and online gaming can all take up a large portion of your Internet connection's bandwidth. You can contact your Internet service provider to upgrade your connection so all your devices have enough bandwidth to share.

Restart your router

If the above steps didn't fix the problem, sometimes the equipment that runs your Internet connection just needs to be restarted. It's a lot like when your laptop or cell phone becomes sluggish after being left on for a few days straight.

Restart your router:

1. Unplug your router's power.
2. Wait for about 15 seconds, then plug your modem back in.
3. After your modem has finished restarting, plug your router back in.
4. After your router has restarted, run another speed test

Move your router

A common cause for possible video problems could be that the Wi-Fi signal is partially blocked by walls between the NightWatcher and router . Another is that the router is too far away for a reliable connection. All Wi-Fi devices can suffer from a poor Wi-Fi signal, but it's often easy to fix – moving your router as close as possible or nearby the installation area of the NW 950 can make a big difference in the Wi-Fi connection quality. You can also try to add a Wi-Fi extender to improve your network's range and get a better signal to your NightWatcher

Retain this manual for future use.



Cape Town-9 Racecourse Road, Milnerton, 7441

Johannesburg-72 5th Street, Wynberg, Sandton 2090

Durban - Talksure House, 62 Umhlanga Ridge Boulevard, Umhlanga, Durban

Web: www.eurolux.co.za